

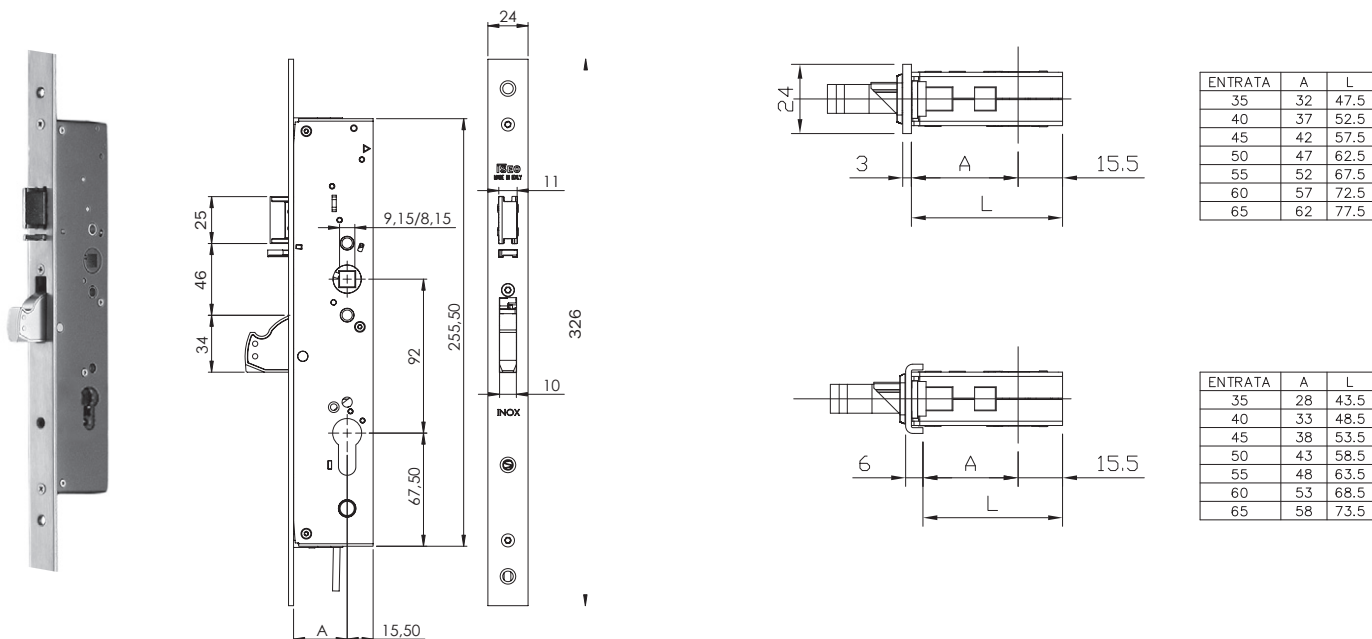

Multiblindo Easy EXIT lateral



ENTRATA	A	L
35	32	47.5
40	37	52.5
45	42	57.5
50	47	62.5
55	52	67.5
60	57	72.5
65	62	77.5

ENTRATA	A	L
35	28	43.5
40	33	48.5
45	38	53.5
50	43	58.5
55	48	63.5
60	53	68.5
65	58	73.5

ОДНОТОЧЕЧНЫЙ ЗАМОК С АВТОМАТИЧЕСКИМ ЗАКРЫВАНИЕМ РИГЕЛЯ С ФУНКЦИЕЙ АНТИПАНИКА. Замок можно использовать с паник-баром PRO EXIT.

центральный замок, межцентровое расстояние 92мм, оснащается европейским профильным цилиндром.

БЕЗ hold-open функции. Встроенный микровыключатель определяет положение ригеля и подаёт звуковой сигнал. Правая или левая защёлка, НЕ РЕВЕРСИВНАЯ. Ригель и защёлка управляются ключом или ручкой. Поворотный ригель с ходом 27мм с защитой от высверливания и разрезания из углеродистой стали. Крепёжные винты. Инструкция.

Аксессуары, приобретаемые отдельно:

U-front plate из нержавеющей стали 24x6:

Механические ответные части 033232 - 033233

Электромеханические ответные части 033242 - 033243

Плоская лицевая планка из нержавеющей стали 24x3:

Механические ответные части 033230 - 033231

Электромеханические ответные части 033240 - 033241

**ОДНОТОЧЕЧНЫЙ ЗАМОК С АВТОМАТИЧЕСКИМ
ЗАКРЫВАНИЕМ РИГЕЛЯ С ФУНКЦИЕЙ АНТИПАНИКА**



Code

Упаковка

мин. заказ

price, €

Multiblindo Easy EXIT lateral

Реальный размер	Flat front-plate 326x24x3 in stainless steel. 9 Handle follower. Backset mm	Code	Упаковка	мин. заказ	price, €
24	35	DIN RIGHT 7A19163522D.A	1	1	96.06
	40	DIN RIGHT 7A19164022D.A	1	1	96.06
	45	DIN RIGHT 7A19164522D.A	1	1	103.45
	50	DIN RIGHT 7A19165022D.A	1	1	103.45
	55	DIN RIGHT 7A19165522D.A	1	1	117,25
	60	DIN RIGHT 7A19166022D.A	1	1	117,25
	65	DIN RIGHT 7A19166522D.A	1	1	131,04
24	35	DIN LEFT 7A19163522S.A	1	1	96.06
	40	DIN LEFT 7A19164022S.A	1	1	96.06
	45	DIN LEFT 7A19164522S.A	1	1	103.45
	50	DIN LEFT 7A19165022S.A	1	1	103.45
	55	DIN LEFT 7A19165522S.A	1	1	117,25
	60	DIN LEFT 7A19166022S.A	1	1	117,25
	65	DIN LEFT 7A19166522S.A	1	1	131,04

Реальный размер	Flat front-plate 326x24x3 in stainless steel. 8 Handle follower. Backset mm	Code	Упаковка	мин. заказ	price, €
24	35	DIN RIGHT 7A12163522D.A	1	1	96.06
	40	DIN RIGHT 7A12164022D.A	1	1	96.06
	45	DIN RIGHT 7A12164522D.A	1	1	103.45
	50	DIN RIGHT 7A12165022D.A	1	1	103.45
	55	DIN RIGHT 7A12165522D.A	1	1	117,25
	60	DIN RIGHT 7A12166022D.A	1	1	117,25
	65	DIN RIGHT 7A12166522D.A	1	1	131,04
24	35	DIN LEFT 7A12163522S.A	1	1	96.06
	40	DIN LEFT 7A12164022S.A	1	1	96.06
	45	DIN LEFT 7A12164522S.A	1	1	103.45
	50	DIN LEFT 7A12165022S.A	1	1	103.45
	55	DIN LEFT 7A12165522S.A	1	1	117,25
	60	DIN LEFT 7A12166022S.A	1	1	117,25
	65	DIN LEFT 7A12166522S.A	1	1	131,04

**ОДНОТОЧЕЧНЫЙ ЗАМОК С АВТОМАТИЧЕСКИМ
ЗАКРЫВАНИЕМ РИГЕЛЯ С ФУНКЦИЕЙ АНТИПАНИКА**



Code

Упаковка

мин. заказ

price, €

Multiblindo Easy EXIT lateral

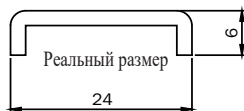

U-front plate 326x24x6 in stainless steel. 9 Handle follower. Backset mm 35 DIN RIGHT 7A19043522D.A	1	☺	1	96,06
U-front plate 326x24x6 in stainless steel. 9 Handle follower. Backset mm 40 DIN RIGHT 7A19044022D.A	1		1	96,06
U-front plate 326x24x6 in stainless steel. 9 Handle follower. Backset mm 45 DIN RIGHT 7A19044522D.A	1		1	103,45
U-front plate 326x24x6 in stainless steel. 9 Handle follower. Backset mm 50 DIN RIGHT 7A19045022D.A	1		1	103,45
U-front plate 326x24x6 in stainless steel. 9 Handle follower. Backset mm 55 DIN RIGHT 7A19045522D.A	1		1	117,25
U-front plate 326x24x6 in stainless steel. 9 Handle follower. Backset mm 60 DIN RIGHT 7A19046022D.A	1		1	117,25
U-front plate 326x24x6 in stainless steel. 9 Handle follower. Backset mm 65 DIN RIGHT 7A19046522D.A	1		1	131,04
U-front plate 326x24x6 in stainless steel. 9 Handle follower. Backset mm 35 DIN LEFT 7A19043522S.A	1		1	96,06
U-front plate 326x24x6 in stainless steel. 9 Handle follower. Backset mm 40 DIN LEFT 7A19044022S.A	1	☺	1	96,06
U-front plate 326x24x6 in stainless steel. 9 Handle follower. Backset mm 45 DIN LEFT 7A19044522S.A	1		1	103,45
U-front plate 326x24x6 in stainless steel. 9 Handle follower. Backset mm 50 DIN LEFT 7A19045022S.A	1		1	103,45
U-front plate 326x24x6 in stainless steel. 9 Handle follower. Backset mm 55 DIN LEFT 7A19045522S.A	1		1	117,25
U-front plate 326x24x6 in stainless steel. 9 Handle follower. Backset mm 60 DIN LEFT 7A19046022S.A	1		1	117,25
U-front plate 326x24x6 in stainless steel. 9 Handle follower. Backset mm 65 DIN LEFT 7A19046522S.A	1		1	131,04

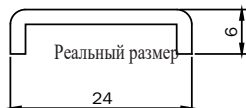

Flat front-plate 326x24x6 in stainless steel. 8 Handle follower. Backset mm 35 DIN RIGHT 7A12043522D.A	1	☺	1	96,06
Flat front-plate 326x24x6 in stainless steel. 8 Handle follower. Backset mm 40 DIN RIGHT 7A12044022D.A	1		1	96,06
Flat front-plate 326x24x6 in stainless steel. 8 Handle follower. Backset mm 45 DIN RIGHT 7A12044522D.A	1		1	103,45
Flat front-plate 326x24x6 in stainless steel. 8 Handle follower. Backset mm 50 DIN RIGHT 7A12045022D.A	1		1	103,45
Flat front-plate 326x24x6 in stainless steel. 8 Handle follower. Backset mm 55 DIN RIGHT 7A12045522D.A	1		1	117,25
Flat front-plate 326x24x6 in stainless steel. 8 Handle follower. Backset mm 60 DIN RIGHT 7A12046022D.A	1		1	117,25
Flat front-plate 326x24x6 in stainless steel. 8 Handle follower. Backset mm 65 DIN RIGHT 7A12046522D.A	1		1	131,04
Flat front-plate 326x24x6 in stainless steel. 8 Handle follower. Backset mm 35 DIN LEFT 7A12043522S.A	1	☺	1	96,06
Flat front-plate 326x24x6 in stainless steel. 8 Handle follower. Backset mm 40 DIN LEFT 7A12044022S.A	1		1	96,06
Flat front-plate 326x24x6 in stainless steel. 8 Handle follower. Backset mm 45 DIN LEFT 7A12044522S.A	1		1	103,45
Flat front-plate 326x24x6 in stainless steel. 8 Handle follower. Backset mm 50 DIN LEFT 7A12045022S.A	1		1	103,45
Flat front-plate 326x24x6 in stainless steel. 8 Handle follower. Backset mm 55 DIN LEFT 7A12045522S.A	1		1	117,25
Flat front-plate 326x24x6 in stainless steel. 8 Handle follower. Backset mm 60 DIN LEFT 7A12046022S.A	1		1	117,25
Flat front-plate 326x24x6 in stainless steel. 8 Handle follower. Backset mm 65 DIN LEFT 7A12046522S.A	1		1	131,04



Code

Упаковка

мин. заказ



price, €

Pro EXIT

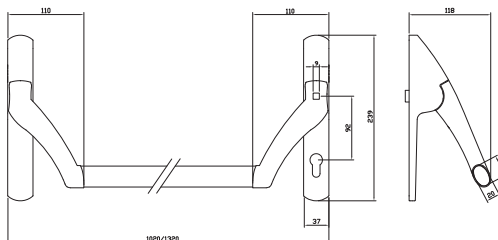

Pro EXIT. Operating bar for Multiblindo Easy EXIT and Multiblindo eMotion EXIT.

92 mm centre distance, handle follower 35°, European cylinder . Square spindle 8 mm. PVD finish (под нержавеющей сталь)	94A000020698		1	1	NO	244
92 mm centre distance, handle follower 35°, European cylinder . Square spindle 8 mm. PAINTED BLACK	94A000050698		1	1	YES	107
92 mm centre distance, handle follower 35°, European cylinder . Square spindle 9 mm. PVD finish (под нержавеющей сталь)	94A000020699		1	1	NO	244
92 mm centre distance, handle follower 35°, European cylinder . Square spindle 9 mm. PAINTED BLACK	94A000050699		1	1	YES	107
94 mm centre distance, handle follower 35°, SWISS profile cylinder . Square spindle 9 mm. PAINTED BLACK	94A000050669		1	1	YES	107
Horizontal oval bar for panic exit devices. Length mm 1130 PAINTED RED	945928		1		YES	8.9
Horizontal oval bar for panic exit devices. Length mm 1330 PAINTED RED	945938		1		YES	20.25
Horizontal oval bar for panic exit devices. Length mm 1330 STAINLESS STEEL	945932		1		NO	71

Operating bar and horizontal bar to be ordered separately.



Microswitch , to be fitted in the Pro EXIT panic exit devices. Can be used in conjunction with security systems. Fixing screws. Instructions sheet.	94100160		1	1		15
---	-----------------	--	---	---	--	-----------

Anti[™]
GERM : antibacterial protection



Code

Упаковка

min. заказ

price €

Multiblindo Easy - Multiblindo Motion

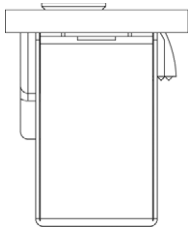

Реальный размер

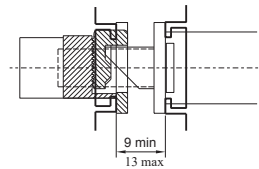
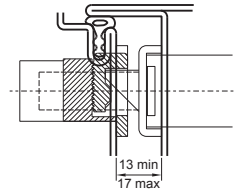
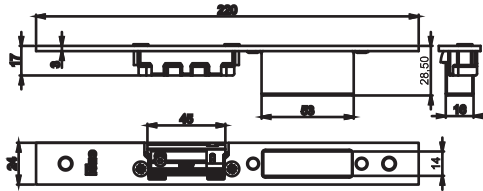

В случае, если пространство между ответной частью и створкой больше, необходимо использовать подкладку для ответной части

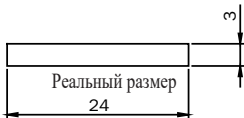

РЕГУЛИРУЕМАЯ закрытая ответная часть для ЦЕНТРАЛЬНОГО ЗАМКА

MULTIBLINDO EASY and MULTIBLINDO EMOTION. Материал: нержавеющая

сталь. С механической ответной частью.

Плоская лицевая планка 24x3x220 DIN LEFT

033230 10 **10** **13,06**

Плоская лицевая планка 24x3x220 DIN RIGHT

033231 10 **10** **13,06**

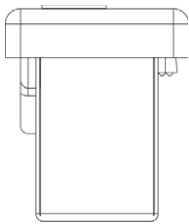

Реальный размер

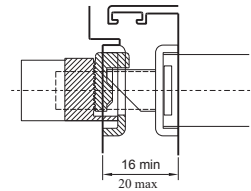
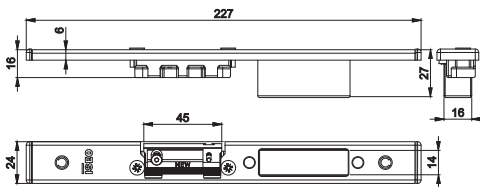

В случае, если пространство между ответной частью и створкой больше, необходимо использовать подкладку для ответной части

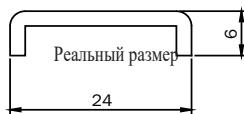

РЕГУЛИРУЕМАЯ закрытая ответная часть для ЦЕНТРАЛЬНОГО ЗАМКА

MULTIBLINDO EASY and MULTIBLINDO EMOTION. Материал: нержавеющая

сталь. С механической ответной частью.

Лицевая планка U-формы 24x6x220 DIN LEFT

033232 10 **10** **13,06**

Лицевая планка U-формы 24x6x220 DIN RIGHT

033233 10 **10** **13,06**